



**OFFICE OF STATEWIDE HEALTH PLANNING AND DEVELOPMENT
FACILITIES DEVELOPMENT DIVISION**

**APPLICATION FOR OSHPD PREAPPROVAL
OF MANUFACTURER'S CERTIFICATION (OPM)**

OFFICE USE ONLY	
APPLICATION #:	OPM-0176-13

OSHPD Preapproval of Manufacturer's Certification (OPM)

Type: New Renewal Update to Pre-CBC 2013 OPA Number: _____

Manufacturer Information

Manufacturer: Beckman Coulter

Manufacturer's Technical Representative: Hendra Tanumihardja

Mailing Address: 250 S. Kramer Blvd., Brea, CA. 92821-6232

Telephone: (800) 526-3821 Email: htanumihardja@beckman.com

Product Information

Product Name: PE Recapper

Product Type: Other Mechanical or Electrical Component

Product Model Number: PR20

General Description: Tube Cap Installer Module for Power Express Diagnostics Lab Automation System

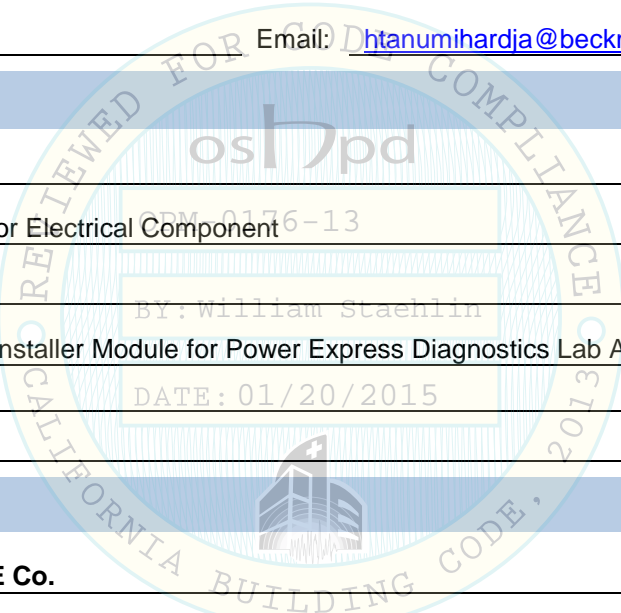

Applicant Information

Applicant Company Name: EASE Co.

Contact Person: Jonathan Roberson, S.E.

Mailing Address: 5877 Pine Ave. Suite 210, Chino Hills, CA. 91709

Telephone: (909) 606-7622 Email: J.Roberson@EASECo.com

I hereby agree to reimburse the Office of Statewide Health Planning and Development review fees in accordance with the California Administrative Code, 2013.

Signature of Applicant:  Date: 12/17/14

Title: Principal Engineer Company Name: EASE Co.

"Access to Safe, Quality Healthcare Environments that Meet California's Diverse and Dynamic Needs"

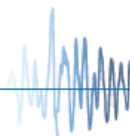



**OFFICE OF STATEWIDE HEALTH PLANNING AND DEVELOPMENT
FACILITIES DEVELOPMENT DIVISION**

Registered Design Professional Preparing Engineering Recommendations

Company Name: EASE Co.

Name: Jonathan Roberson, S.E. California License Number: S4197

Mailing Address: 5877 Pine Ave. Suite 210, Chino Hills, CA. 91709

Telephone: 909-606-7667 Email: J.Roberson@EASECo.com

OSHPD Special Seismic Certification Preapproval (OSP)

- Special Seismic Certification is preapproved under OSP- (Separate application for OSP is required)
- Special Seismic Certification is not preapproved

Certification Method(s)

- Testing in accordance with: ICC-ES AC156 FM 1950-10
- Other* (Please Specify): _____

*Use of test criteria other than those adopted by the California Building Standards Code, 2013 (CBSC 2013) for component supports and attachments are not permitted. For distribution system, interior partition wall, and suspended ceiling seismic bracings, test criteria other than those adopted in the CBSC 2013 may be used when approved by OSHPD prior to testing.

- Analysis
- Experience Data
- Combination of Testing, Analysis, and/or Experience Data (Please Specify): _____

List of Attachments Supporting the Manufacturer's Certification

- Test Report Drawings Calculations Manufacturer's Catalog
- Other(s) (Please Specify): _____

OFFICE USE ONLY – OSHPD APPROVAL VALID FOR CBC 2013 ONLY

Signature: *William Staehlin* Date: 01/20/2015

Print Name: William Staehlin

Title: SSE

Condition of Approval (if applicable): _____

"Access to Safe, Quality Healthcare Environments that Meet California's Diverse and Dynamic Needs"

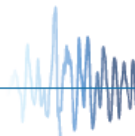



**EQUIPMENT ANCHORAGE
& SEISMIC ENGINEERING**

5877 Pine Ave, Ste. 210
Chino Hills, CA. 91709
Phn: (909) 606-7622

Office of Statewide Health Planning and Development
PREAPPROVAL OF MANUFACTURER'S CERTIFICATION
OPM-0176-13

THIS PREAPPROVAL CONFORMS TO THE 2013 CALIFORNIA BUILDING CODE

MANUFACTURER: **BECKMAN COULTER**
EQUIPMENT NAME: **PE RECAPPER**

Sheet: 1 of 8
Date: 1/6/15

GENERAL NOTES

1. THIS OSHPD PREAPPROVAL OF MANUFACTURER'S CERTIFICATION (OPM) IS BASED ON THE 2013 CBC. THE DEMANDS (DESIGN FORCES) FOR USE WITH THIS OPM SHALL BE BASED ON THE 2013 CBC
2. THIS DOCUMENT MAY ONLY BE USED WITH THE EXPRESS WRITTEN CONSENT OF THE MANUFACTURER LISTED ABOVE FOR THE SPECIFIC PROJECT SITE AND INSTALLATION LOCATION. THIS DOCUMENT IS INVALID WITHOUT SUCH CONSENT.
3. THIS PREAPPROVAL CONFORMS TO THE 2013 CALIFORNIA BUILDING CODE WHERE S_{ds} IS NOT GREATER THAN 2.20. SEE DETAIL FOR APPLICABILITY
4. FORCES PER ASCE 7-10 SECTION 13.3.1, EQUATIONS 13.3-1, 13.3-2 & 13.3-3, WHERE $S_{ds} = 2.20$, $a_p = 1.0$, $I_p = 1.5$, $R_p = 1.5$, $z/h = 0$ AT CONCRETE SLAB & $z/h < 1$ AT CONCRETE SLAB ON METAL DECK. SEE FOLLOWING SHEETS FOR Ω_o
5. THIS PREAPPROVAL COVERS ONLY THE SUPPORTS AND ATTACHMENTS OF THE EQUIPMENT TO THE STRUCTURE.
6. ALL DESIGN FORCES SHOWN ON THE DRAWINGS ARE FACTORED LOADS THAT SHALL BE USED FOR STRENGTH DESIGN.
7. CONCRETE SLAB ON METAL DECK DETAIL VALID FOR DEMANDS SHOWN AT ANY ELEVATION IN THE BUILDING. (i.e. $z/h \leq 1$)
8. CONCRETE SLAB ON GRADE DETAIL VALID FOR DEMANDS SHOWN AT ANY ELEVATION BELOW GRADE. (i.e. $z/h \leq 0$)
9. **RESPONSIBILITIES OF THE STRUCTURAL ENGINEER OF RECORD OF THE BUILDING**
 - A. PROVIDE SUPPORTING STRUCTURE TO SUPPORT WEIGHTS AND FORCES SHOWN IN ADDITION TO ALL OTHER LOADS.
 - B. VERIFY THAT THE INSTALLATION IS IN CONFORMANCE WITH THE 2013 CBC AND WITH THE DETAILS, MATERIAL AND GAGE OF THE UNIT WHERE ATTACHMENTS ARE MADE AGREE WITH THE INFORMATION SHOWN ON THE PREAPPROVAL DOCUMENTS.
 - C. VERIFY THAT PROJECT SPECIFIC VALUES OF S_{ds} & z/h RESULT IN SEISMIC FORCES (E_h , E_v) THAT DO NOT EXCEED THE VALUES ON THE DETAILS.
 - D. VERIFY THAT THE CONCRETE SLAB TO WHICH THE EQUIPMENT IS ANCHORED MEETS THE REQUIREMENTS OF THE APPLICABLE ICC ESR.
 - E. VERIFY THAT THE ANCHORS ARE AN ADEQUATE DISTANCE FROM ANY SLAB EDGES OR OPENINGS (SEE TYPICAL DETAIL ON SHEET 2).
 - F. VERIFY THAT ALL NEW OR EXISTING ANCHORS ARE AN ADEQUATE DISTANCE FROM THE UNIT ATTACHMENTS AND CHECK FOR INTERACTION WHERE OTHER ANCHORS ARE WITHIN 18" OR $6h_{ef}$ FROM THIS UNIT'S ANCHORS.

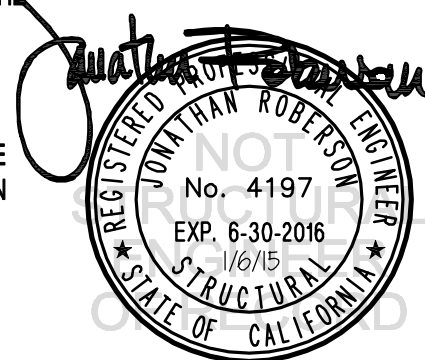

BECKMAN COULTER

PE RECAPPER

DES. **J. ROBERSON**

JOB NO. **11-1416**

DATE **1/6/15**

SHEET

2

OF **8** SHEETS

10. EXPANSION ANCHORS:

A. ATTACHMENT IS TO BE MADE WITH THE ANCHORS LISTED BELOW AND INSTALLED AS DESCRIBED IN THE CORRESPONDING ICC REPORT.

Anchor Diameter	Concrete Type	Min. f _c (psi)	Anchor Type	ICC Report No.	Min. Embed.	Min. Spacing	Min. Edge Dist.	Min. Conc. Thickness	Torque Test	Direct Tension
3/8"	Sand Light Weight	3000	Hilti Kwik Bolt TZ	ESR-1917	2"	N/A	N/A	See Sheet 7 of 8	25 FT-LB	1186 lb
1/2"	Normal Weight	3000	Hilti Kwik Bolt TZ	ESR-1917	2"	4"	9"	4"	40 FT-LB	1338 lb

B. THIS PREAPPROVAL ALLOWS FOR UP TO A MAXIMUM OF 2 ADJACENT CONCRETE SLAB EDGES, 9" AWAY MINIMUM (i.e. - CORNER). SEE ADJACENT DETAIL FOR ADDITIONAL MINIMUM ALLOWABLE CONCRETE EDGE DISTANCES.

C. TESTING OF EXPANSION ANCHORS PER 2013 CBC, 1913A.7: TESTING SHALL BE DONE IN THE PRESENCE OF THE SPECIAL INSPECTOR AND A REPORT OF THE TEST RESULTS SHALL BE SUBMITTED TO OSHPD

(i) AFTER AT LEAST 24 HOURS HAVE ELAPSED SINCE INSTALLATION, DIRECT PULL TENSION TEST OR TORQUE TEST AT LEAST 50% OF THE ANCHORS.

(ii) ACCEPTANCE CRITERIA:

- DIRECT TENSION TEST: THE ANCHOR SHOULD HAVE NO OBSERVABLE MOVEMENT AT THE TEST LOAD. A PRACTICAL WAY TO DETERMINE OBSERVABLE MOVEMENT IS THAT THE WASHER BECOMES LOOSE.
- TORQUE TEST: THE APPLICABLE TORQUE MUST BE ACHIEVED WITHIN THE FOLLOWING LIMITS: WEDGE TYPE : 1/2 TURN OF THE NUT

(iii) IF ANY ANCHOR FAILS, TEST ALL ANCHORS.

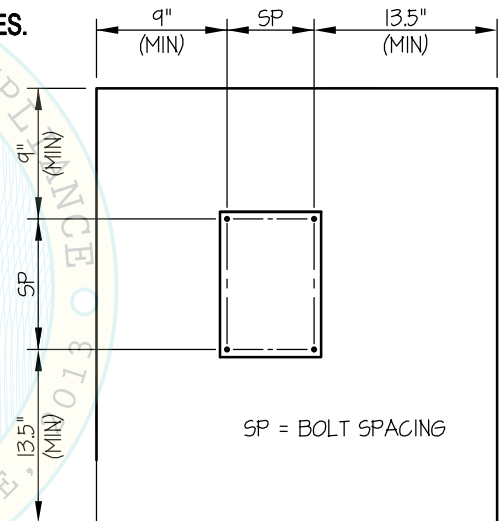

TYPICAL CONCRETE EDGE DETAIL

11. BOLTS THROUGH CONCRETE ON METAL DECK

- BOLTS SHALL BE TORQUED BY 3/4 TURN OF THE NUTS AFTER THE SNUG TIGHT (THE SNUG-TIGHT CONDITION IS DEFINED AS THE TIGHTNESS REQUIRED TO BRING THE CONNECTED PLIES INTO FIRM CONTACT) CONDITION IS ACHIEVED, UNLESS OTHERWISE NOTED.
- THROUGH BOLT HOLES SHALL BE 1/16" LARGER THAN BOLT SIZE (HOLE SIZE = BOLT SIZE + 1/16) FOR CONCRETE.
- THROUGH-BOLTS IN CONCRETE SHALL RECEIVE SPECIAL INSPECTION AND TESTING (THROUGH BOLTS WITH STEEL TO STEEL CONNECTION IN TENSION DO NOT REQUIRE TENSION TESTING) IN ACCORDANCE WITH REQUIREMENTS FOR POST-INSTALLED ANCHORS.



BECKMAN COULTER

PE RECAPPER

DES. **J. ROBERSON**

JOB NO. **11-1416**

DATE **1/6/15**

SHEET

3

OF **8** SHEETS

SEISMIC SUPPORTS & ATTACHMENTS

CONCRETE SLAB

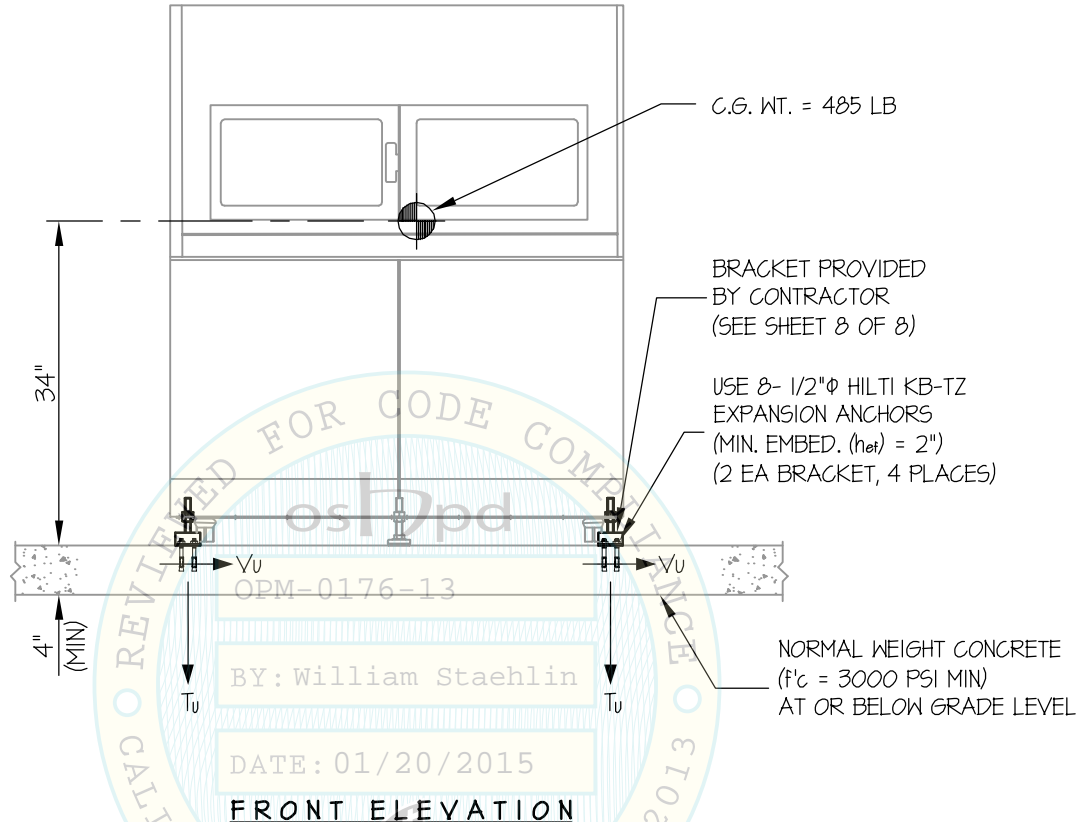

$T_u = 1009$ LB/BOLT (MAX)
 $V_u = 196$ LB/BOLT (MAX)
(VALUES INCLUDE Ω)

NOTES:

- FORCES ARE DETERMINED PER 2013 CALIFORNIA BUILDING CODE AND ASCE 7-10 STRENGTH DESIGN IS USED. ($S_{Ds} = 2.2$, $a_p = 1.0$, $I_p = 1.5$, $R_p = 1.5$, $\Omega_o = 1.5$, $z/h = 0$)

HORIZONTAL FORCE (E_h) = $0.99 W_p$

HORIZONTAL FORCE (E_{mh}) = $1.49 W_p$ (FOR CONCRETE ANCHORAGE)

VERTICAL FORCE (E_v) = $0.44 W_p$

- CENTER OF GRAVITY (C.G.) AND WEIGHT ARE THE GOVERNING PARAMETERS FOR DESIGN. THIS PREAPPROVAL ENCOMPASSES ALL WEIGHTS UP TO THE MAXIMUM WEIGHT SHOWN.
- STRUCTURAL ENGINEER OF RECORD FOR THE BUILDING SHALL PROVIDE SUPPORT STRUCTURE DESIGNED TO SUPPORT WEIGHTS AND FORCES SHOWN IN COMBINATION WITH ALL OTHER LOADS THAT MAY BE PRESENT.
- SEE GENERAL NOTES: SHEETS 1 AND 2

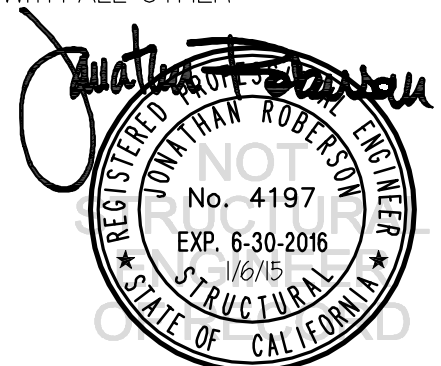

BECKMAN COULTER

PE RECAPPER

DES. J. ROBERSON

JOB NO. 11-1416

DATE 1/6/15

SHEET

4

OF 8 SHEETS

SEISMIC SUPPORTS & ATTACHMENTS

CONCRETE SLAB

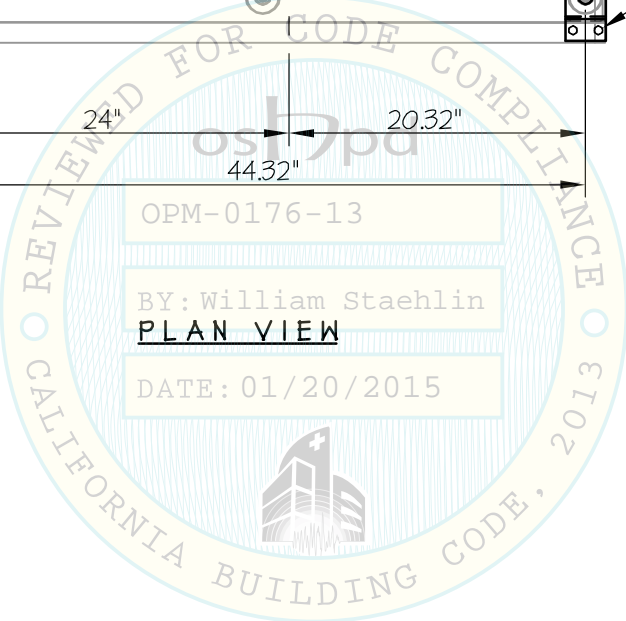
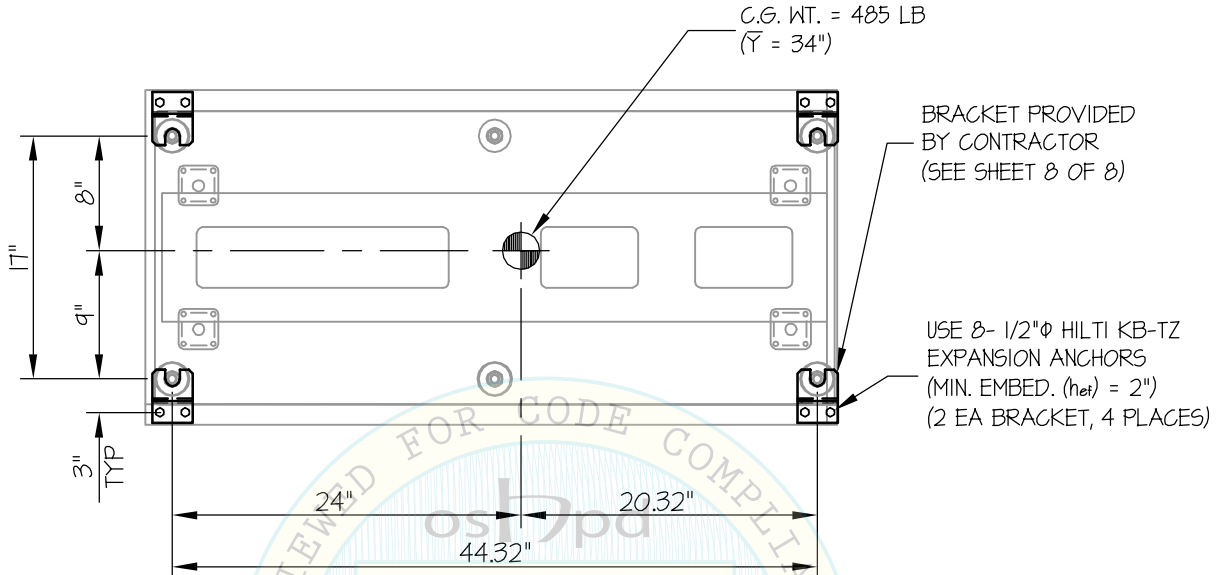

BECKMAN COULTER

PE RECAPPER

DES. **J. ROBERSON**

JOB NO. **11-1416**

DATE **1/6/15**

SHEET

5

OF **8** SHEETS

SEISMIC SUPPORTS & ATTACHMENTS

CONCRETE SLAB

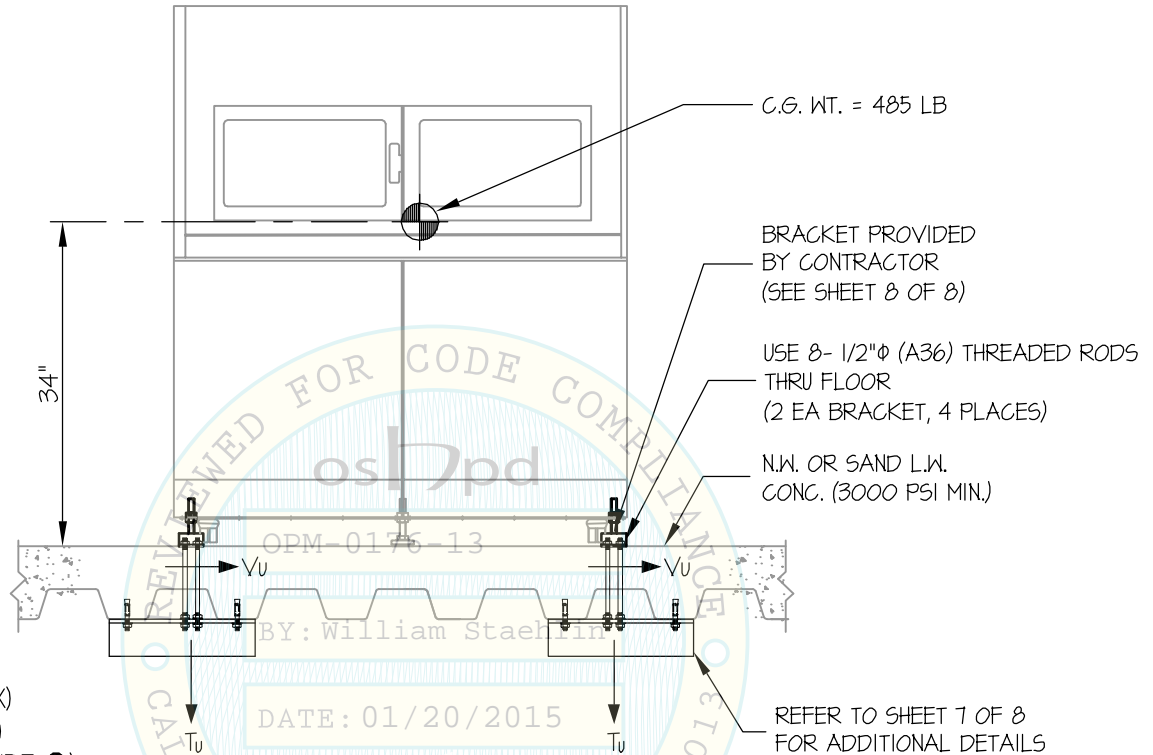

$T_u = 1849$ LB/BOLT (MAX)
 $V_u = 347$ LB/BOLT (MAX)
 (VALUES DO NOT INCLUDE Ω)

FRONT ELEVATION

NOTES:

- FORCES ARE DETERMINED PER 2013 CALIFORNIA BUILDING CODE AND ASCE 7-10. STRENGTH DESIGN IS USED. ($S_{Ds} = 2.2$, $a_p = 1.0$, $I_p = 1.5$, $R_p = 1.5$, $\Omega_o = 1.5$, $z/h \leq 1$)
 HORIZONTAL FORCE (E_h) = $2.64 W_p$
 HORIZONTAL FORCE (E_{mh}) = $3.96 W_p$ (FOR CONCRETE ANCHORAGE)
 VERTICAL FORCE (E_v) = $0.44 W_p$
- CENTER OF GRAVITY (C.G.) AND WEIGHT ARE THE GOVERNING PARAMETERS FOR DESIGN. THIS PREAPPROVAL ENCOMPASSES ALL WEIGHTS UP TO THE MAXIMUM WEIGHT SHOWN.
- STRUCTURAL ENGINEER OF RECORD FOR THE BUILDING SHALL PROVIDE SUPPORT STRUCTURE DESIGNED TO SUPPORT WEIGHTS AND FORCES SHOWN IN COMBINATION WITH ALL OTHER LOADS THAT MAY BE PRESENT.
- SEE GENERAL NOTES: SHEETS 1 AND 2



BECKMAN COULTER

PE RECAPPER

DES. J. ROBERSON

JOB NO. 11-1416

DATE 1/6/15

SHEET

6

OF 8 SHEETS

SEISMIC SUPPORTS & ATTACHMENTS

CONCRETE SLAB ON METAL DECK

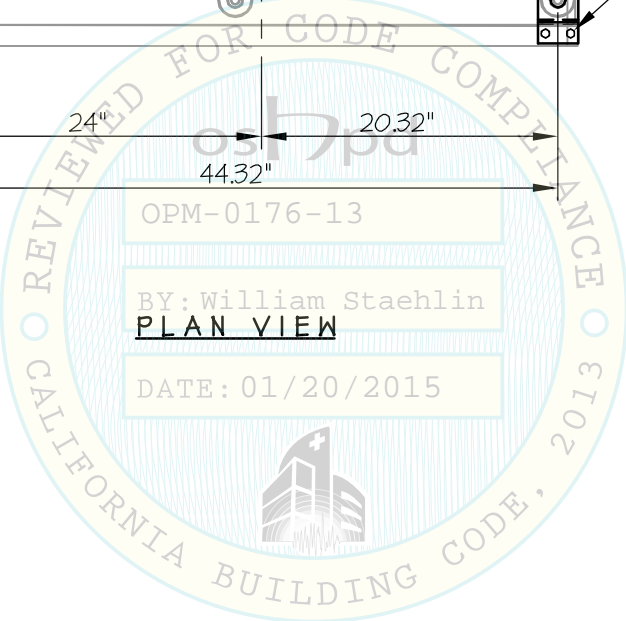
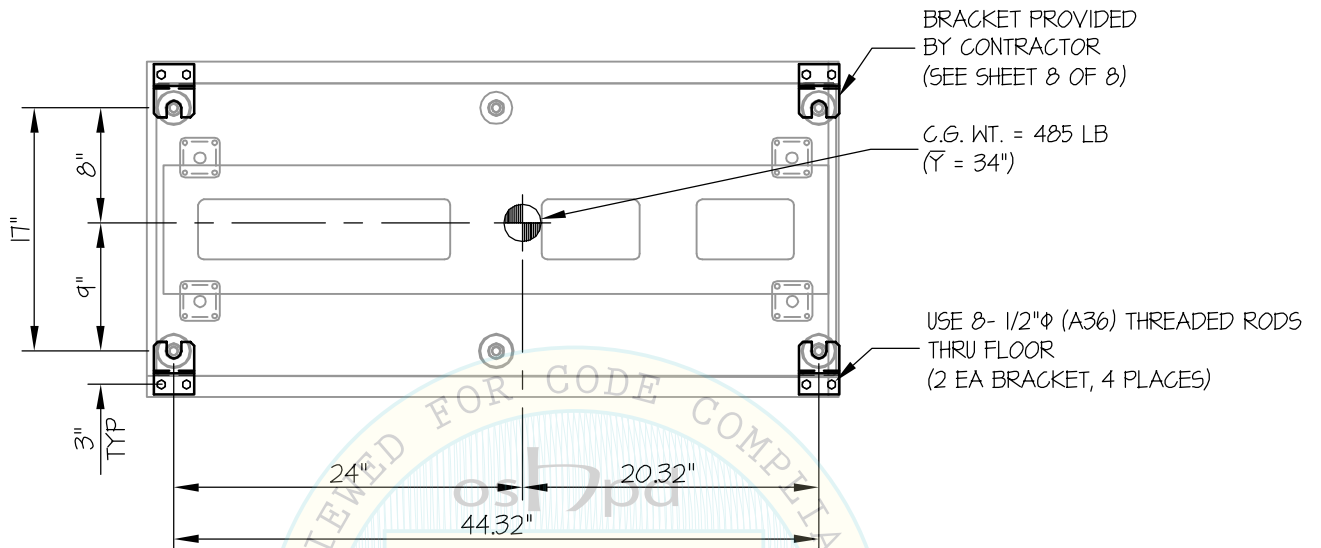

BECKMAN COULTER

PE RECAPPER

DES. **J. ROBERSON**

JOB NO. **11-1416**

DATE **1/6/15**

SHEET

7

OF **8** SHEETS

SEISMIC SUPPORTS & ATTACHMENTS

CONCRETE DETAILS

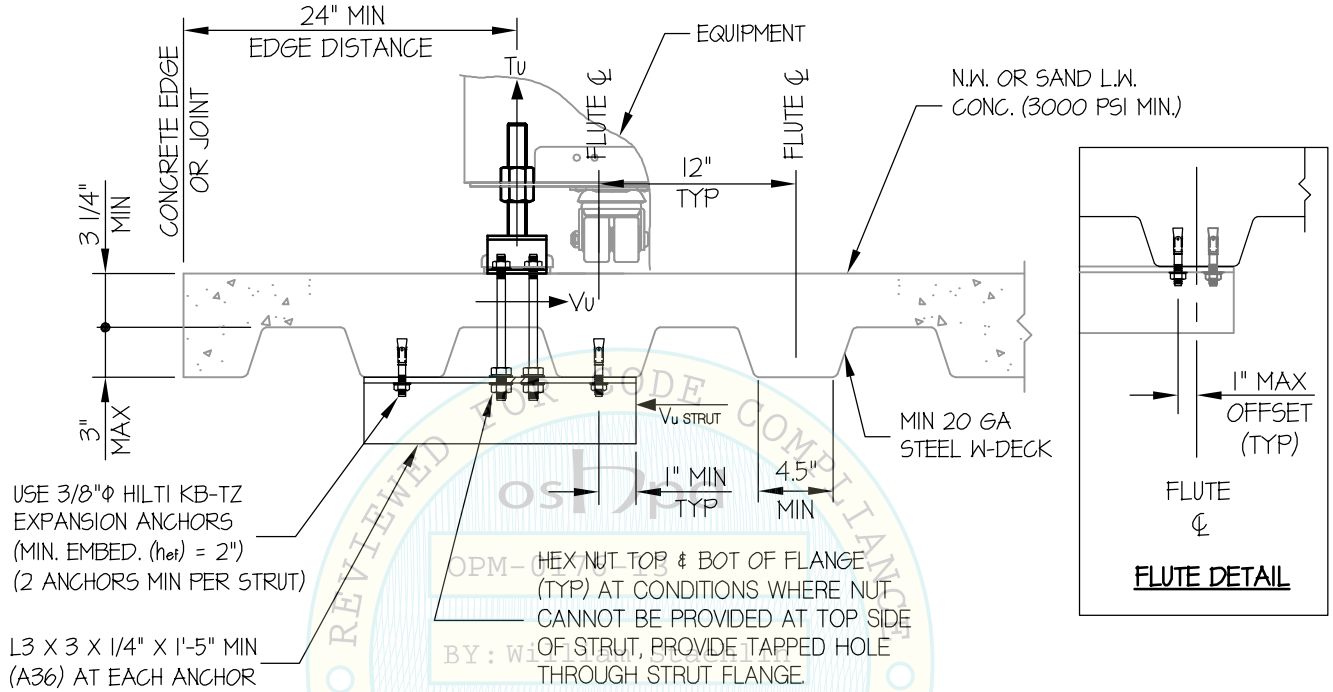

MIN STEEL DECK REQUIREMENTS AND STRUT DETAIL



BECKMAN COULTER

PE RECAPPER

DES. **J. ROBERSON**

JOB NO. **11-1416**

DATE **1/6/15**

SHEET

8

OF **8** SHEETS

SEISMIC SUPPORTS & ATTACHMENTS

BRACKET DETAILS

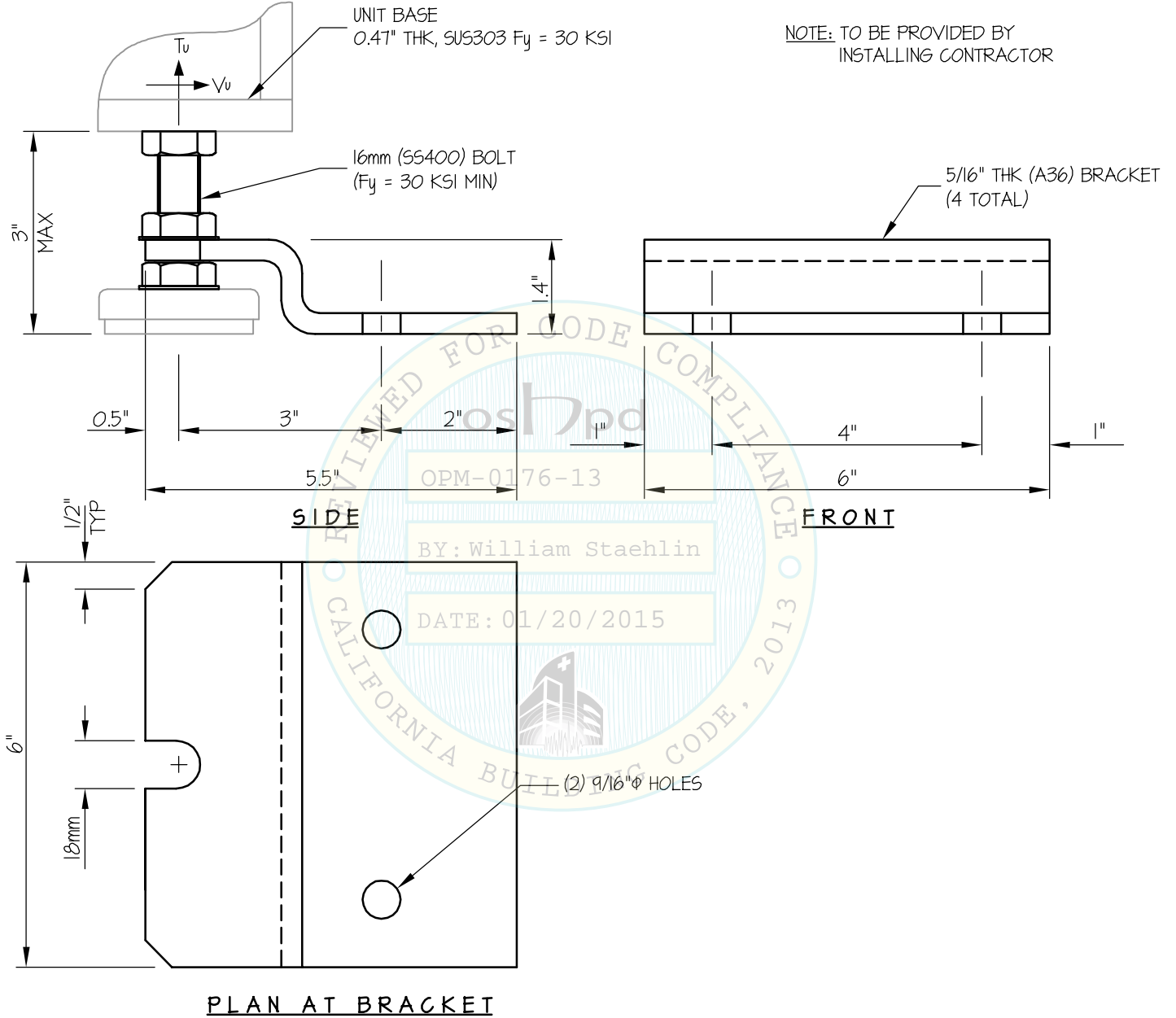

Jonathan Roberson

REGISTERED PROFESSIONAL ENGINEER
No. 4197
EXP. 6-30-2016
1/6/15
STRUCTURAL
STATE OF CALIFORNIA